

Proson

Proson

RV 2200

AM/FM Stereo Receiver

OWNER'S MANUAL

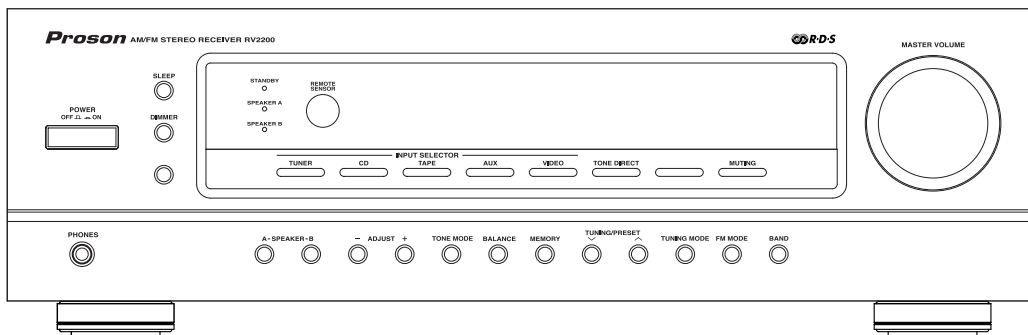

CE

Introduction

UNPACKING AND INSTALLATION



Congratulations on Your Purchase!

Your new high fidelity receiver is designed to deliver maximum enjoyment and years of trouble free service.

Please take a few moments to read this manual thoroughly. It will explain the features and operation of your unit and help ensure a trouble free installation.

Please unpack your unit carefully. We recommend that you save the carton and packing material. They will be helpful if you ever need to move your unit and may be required if you ever need to return it for service. Your unit is designed to be placed in a horizontal position and it is important to allow at least two inches of space behind your unit for adequate ventilation and cabling convenience.

To avoid damage, never place the unit near radiators, in front of heating vents, in direct sunlight, or in excessively humid or dusty locations. Connect your complementary components as illustrated in the following section.

	CAUTION RISK OF ELECTRIC SHOCK DO NOT OPEN	
CAUTION : TO REDUCE THE RISK OF ELECTRIC SHOCK, DO NOT REMOVE COVER (OR BACK). NO USER-SERVICEABLE PARTS INSIDE. REFER SERVICING TO QUALIFIED SERVICE PERSONNEL.		



This symbol is intended to alert the user to the presence of uninsulated "dangerous voltage" within the product's enclosure that may be of sufficient magnitude to constitute a risk of electric shock to persons.



This symbol is intended to alert the user to the presence of important operating and maintenance (servicing) instructions in the literature accompanying the appliance.

WARNING

To reduce the risk of fire or electric shock, do not expose this appliance to rain or moisture.

Caution : Do not block ventilation openings or stack other equipment on the top.

FOR U.S.A.

■ **Note to CATV System Installer:** This reminder is provided to call the CATV system installer's attention to Article 820-40 of the NEC that provides guidelines for proper grounding and, in particular, specifies that the cable ground shall be connected to the grounding system of the building, as close to the point of cable entry as practical.

■ **FCC INFORMATION**

This equipment has been tested and found to comply with the limits for a Class B digital device, pursuant to Part 15 of the FCC Rules. These limits are designed to provide reasonable protection against harmful interference in a residential installation. This equipment generates, uses and can radiate radio frequency energy and, if not installed and used in accordance with the instructions, may cause harmful interference to radio communications. However, there is no guarantee that interference will not occur in a particular installation. If this equipment does cause harmful interference to radio or television reception, which can be determined by turning the equipment off and on, the user is encouraged to try to correct the interference by one or more of the following measures:

- Reorient or relocate the receiving antenna.
- Increase the separation between the equipment and receiver.
- Connect the equipment into an outlet on a circuit different from that to which the receiver is connected.
- Consult the dealer or an experienced radio/TV technician for help.

CAUTION: Any changes or modifications in construction of this device which are not expressly approved by the party responsible for compliance could void the user's authority to operate the equipment.

Caution regarding placement (Except for U.S.A. and Canada)

To maintain proper ventilation, be sure to leave a space around the unit (from the largest outer dimensions including projections) equal to, or greater than, shown below.

Left and right panels: 10 cm
Rear panel: 10 cm
Top panel: 50 cm



READ THIS BEFORE OPERATING YOUR UNIT

FOR U.S.A AND CANADA 120 V

FOR YOUR SAFETY

Units shipped to the U.S.A and Canada are designed for operation on 120 V AC only.

Safety precaution with use of a polarized AC plug. However, some products may be supplied with a nonpolarized plug.

CAUTION : To prevent electric shock, match wide blade of plug to wide slot, fully insert.

FOR CHINA, EUROPE AND AUSTRALIA 220V/230V/240V

FOR YOUR SAFETY

Units shipped to China are designed for operation on 220 V AC only.

Units shipped to Australia are designed for operation on 240 V AC only.

To ensure safe operation, the three-pin plug supplied must be inserted only into a standard three-pin power point which is effectively earthed through the normal household wiring. Extension cords used with the equipment must be three-core and be correctly wired to provide connection to earth.

Improper extension cords are a major cause of fatalities. The fact that the equipment operates satisfactorily does not imply that the power point is earthed and that the installation is completely safe. For your safety, if in any doubt about the effective earthing of the power point, consult a qualified electrician.

PAN-EUROPEAN UNIFIED VOLTAGE

All units are suitable for use on supplies 230-240 V AC.

FOR OTHER COUNTRIES 115 V/230 V

FOR YOUR SAFETY

Units shipped to countries other than the above countries are equipped with an AC voltage selector switch on the rear panel. Refer to the following paragraph for the proper setting of this switch.

AC VOLTAGE SELECTION

This unit operates on 115/230 V AC. The AC voltage selector switch on the rear panel is set to the voltage that prevails in the area to which the unit is shipped. Before connecting the power cord to your AC outlet, make sure that the setting position of this switch matches your line voltage. If not, it must be set to your voltage in accordance with the following direction.

AC voltage selector switch

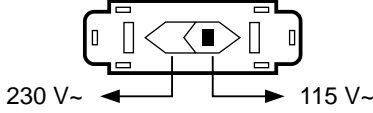

Move switch lever to match your line voltage with a small screwdriver or other pointed tool.

CONTENTS

Introduction	
• UNPACKING AND INSTALLATION	2
• READ THIS BEFORE OPERATING YOUR UNIT	3
System Connections	5
Front Panel & Remote Controls	7
• REMOTE CONTROL OPERATION RANGE	9
• LOADING BATTERIES	9
Operations	
• LISTENING TO A PROGRAM SOURCE	10
• LISTENING TO RADIO BROADCASTS	12
• LISTENING TO RDS BROADCASTS(FM ONLY)	14
• RECORDING	15
• OTHER FUNCTIONS	16
Troubleshooting Guide	17
Specifications	18

System Connections

- Do not plug the AC input cord into the wall AC outlet until all connections are completed.
- Be sure to connect the white RCA pin cords to the L(left) and the red RCA pin cords to the R(right) jacks when making audio connections.
- Change the position of the FM indoor antenna until you get the best reception of your favorite FM stations.
- A 75 ohm outdoor FM antenna may be used to further improve the reception.
Disconnect the indoor antenna before replacing it with the outdoor one.
- Place the AM loop antenna as far as possible from the receiver, TV set, speaker cords and the AC input cord and set it to a direction for the best reception.
- If the reception is poor with the AM loop antenna, an AM outdoor antenna can be used in place of the AM loop antenna.
- Make connections firmly and correctly. If not, it can cause loss of sound, noise or damage to the receiver.
- If the electricity fails or the AC input cord is left unplugged for more than several days, the memorized contents will be cleared.
Should this happen, memorize them again.

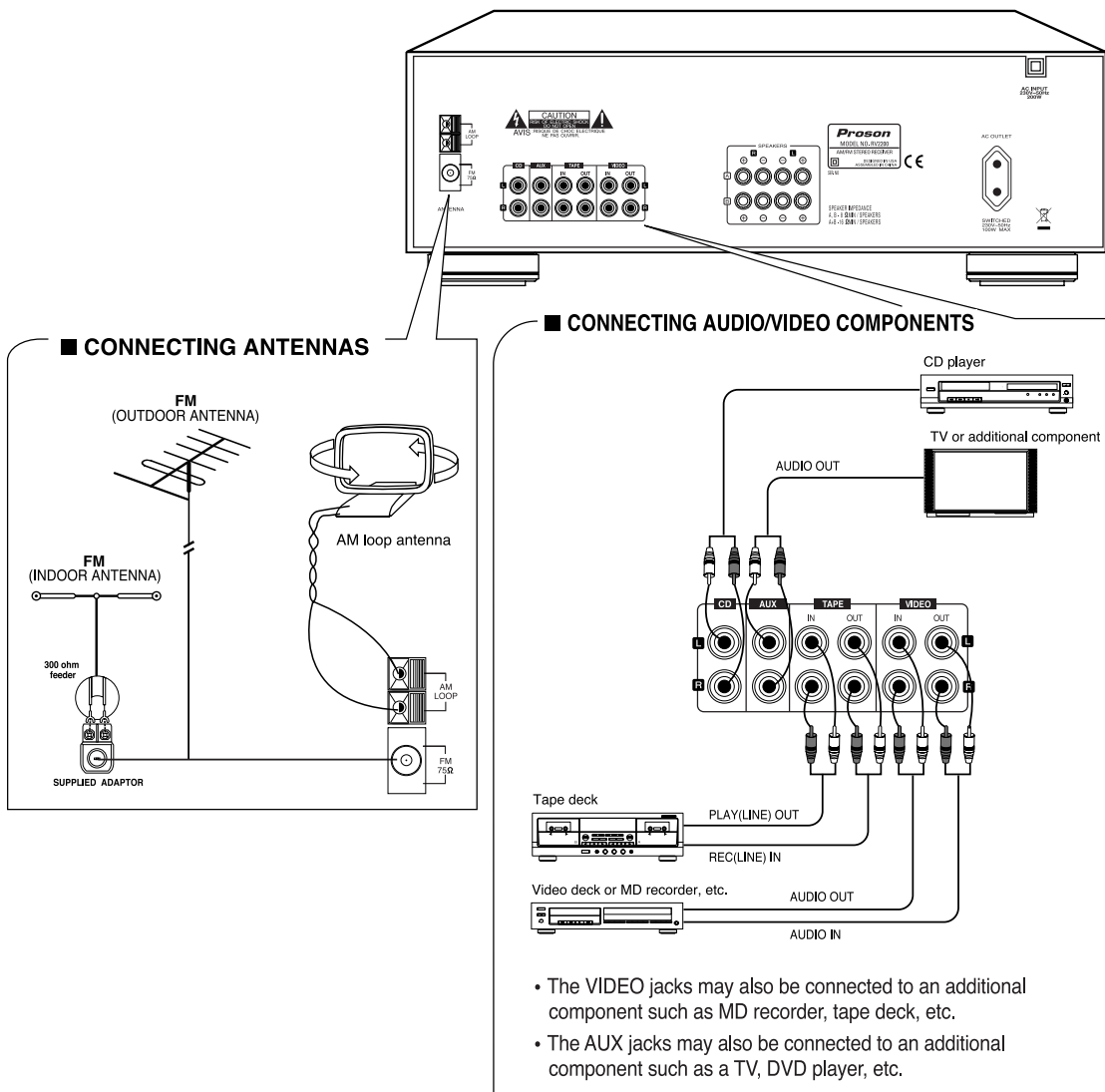

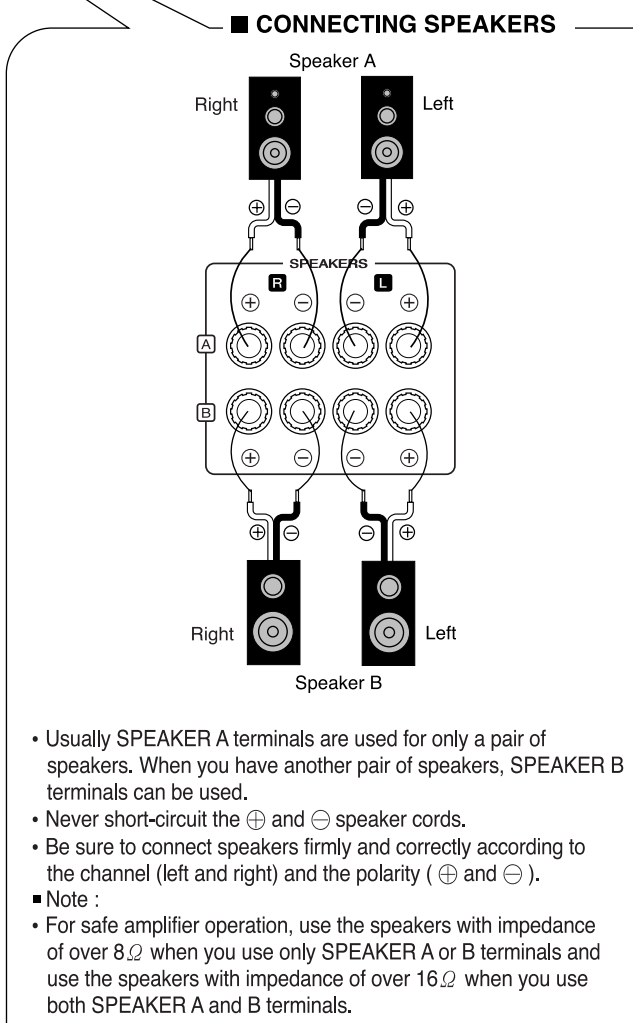
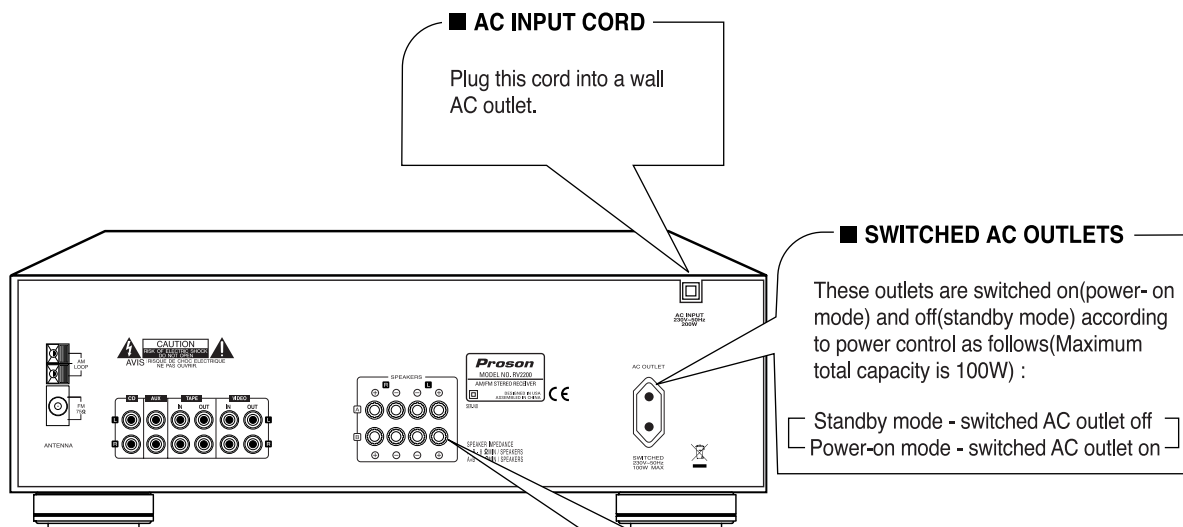

Front Panel & Remote Controls

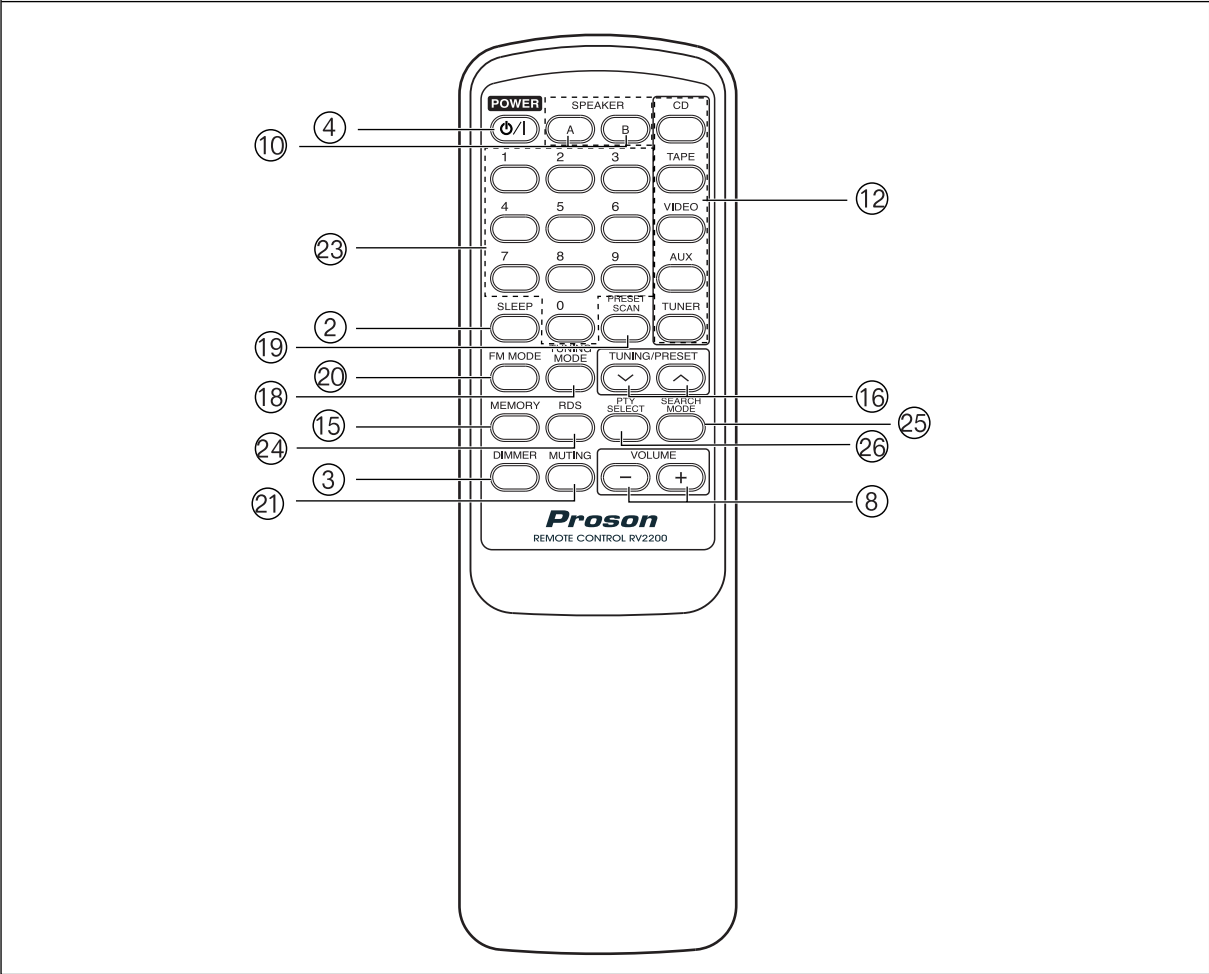
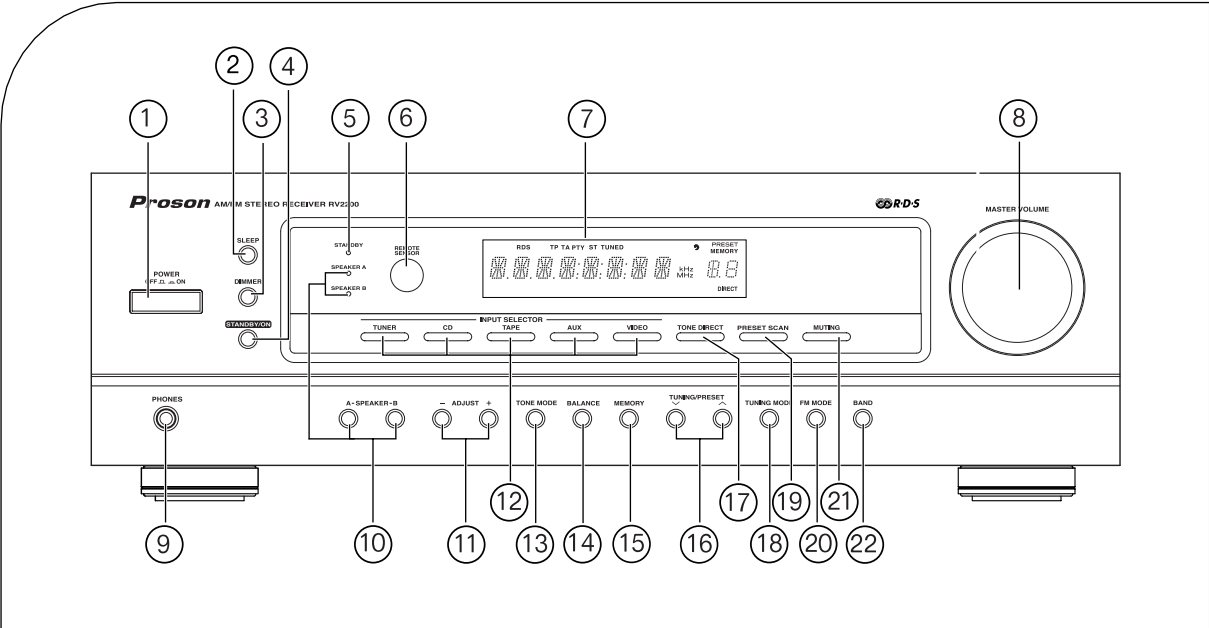

① POWER SWITCH

Press this switch to turn the unit standby or off.

② SLEEP BUTTON

Press this button to activate the sleep timer for a specified period of time.

- Each time this button is pressed, the sleep time changes as follows:

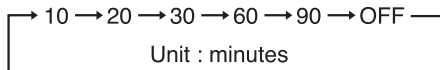

③ DIMMER BUTTON

Press this button to select the brightness of the fluorescent display as desired.

- Each time this button is pressed, the brightness of the fluorescent display changes together as follows:

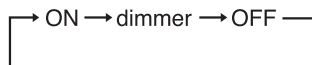

④ STANDBY/ON BUTTON

In the operating mode, when this button is pressed, the unit is turned off to enter the standby mode.

⑤ STANDBY INDICATOR

⑥ REMOTE SENSOR

This receives the signals from the remote control unit.

⑦ FLUORESCENT DISPLAY

For details, see the next page.

⑧ VOLUME CONTROL KNOB, UP/DOWN(+/ -) BUTTONS

Adjust the volume to a comfortable listening level with this knob or these buttons.

⑨ HEADPHONE JACK

Stereo headphones with a standard 1/4 inch plug can be plugged into this jack for private listening.

⑩ SPEAKER A, B SELECTOR BUTTONS

These buttons allow you to select various combinations of speakers as follows:

- To drive A speakers, press only the SPEAKER A button ("SPK A" is displayed and the speaker A indicator lights up).
- To drive B speakers, press only the SPEAKER B button ("SPK B" is displayed and the speaker B indicator lights up).
- To drive both A and B speakers, press the SPEAKER A(or B) and B(or A) buttons in order. ("SPK A B" is displayed and both of the speaker A,B indicator lights up).
- When using headphones for private listening, press these buttons in order to switch off the speaker A and B ("SPK OFF" is displayed).

⑪ ADJUST (-,+) BUTTONS

At the balance or tone mode, use these buttons to change the setting.

⑫ INPUT SELECTOR BUTTONS

Press the button to select the desired input source.

⑬ TONE MODE BUTTON

When adjusting the tone (bass and treble), press this button to select the desired tone mode.

- Each time this button is pressed, the tone mode is changed to bass or treble.

⑭ BALANCE BUTTON

When adjusting the sound volume balance, press this button to enter the balance mode.

⑮ MEMORY BUTTON

Press this button to store preset stations.

⑯ TUNING/PRESET UP/DOWN(^ / v) BUTTONS

Press these buttons to tune in the desired stations.

⑰ TONE DIRECT BUTTON

Press this button to listen to a program source without the tone effect.

⑱ TUNING MODE BUTTON

Press this button to select the tuning mode or the preset mode.

⑲ PRESET SCAN BUTTON

Press this button to scan the stations in the preset sequence.

⑳ FM MODE BUTTON

Press this button to select the desired FM mode.

- Each time this button is pressed, the FM mode is changed to the stereo mode or the mono mode.

㉑ MUTING BUTTON

Press this button to temporarily mute the sound. Press again to resume the previous sound level.

㉒ BAND BUTTON

Press this button to select FM or AM.

㉓ NUMERIC BUTTONS(0 ~ 9)

Press these buttons to select or to store preset stations directly.

㉔ RDS BUTTON

Press this button to select RDS mode.

㉕ SEARCH MODE BUTTON

Press this button to select Search mode.

㉖ PTY SELECT BUTTON

Press this button to select Type of programs.

■ FLUORESCENT DISPLAY

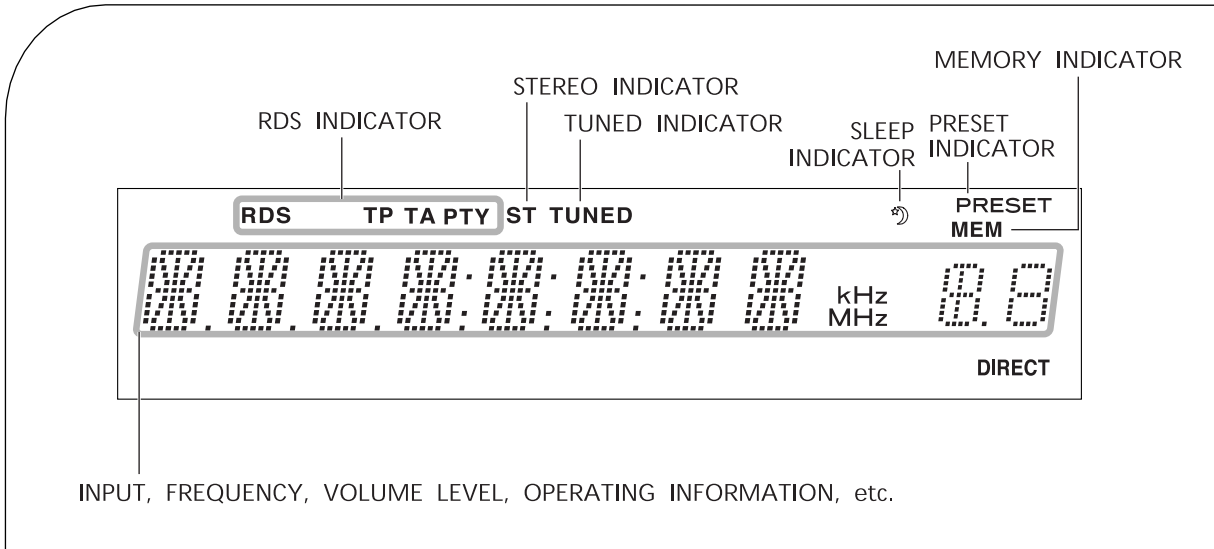

REMOTE CONTROL OPERATION RANGE

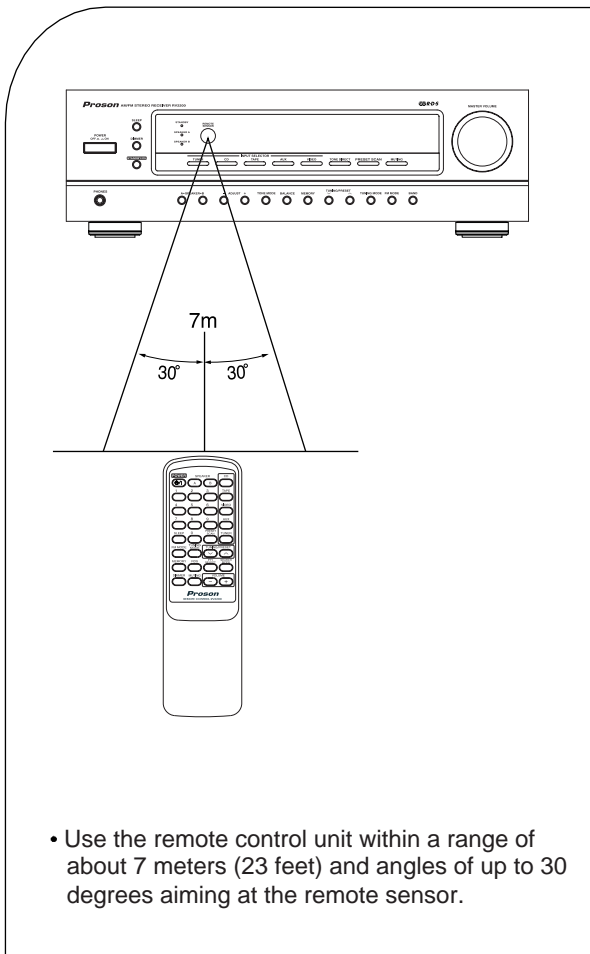

LOADING BATTERIES

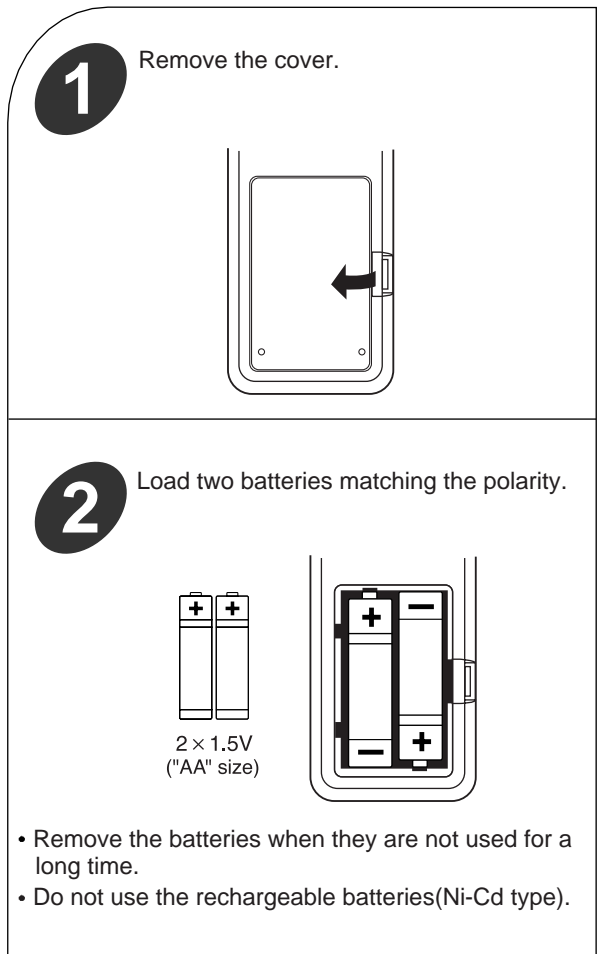

Operations

LISTENING TO A PROGRAM SOURCE

Before operation

· Push the POWER switch

- This unit enters the standby mode. The lighting of STANDBY indicator means that the receiver is not disconnected from the AC mains and a small amount of current is retained to support the memorized contents and operation readiness.
- To switch the power off, push the POWER switch again. Then the power is cut off and the STANDBY indicator goes off.

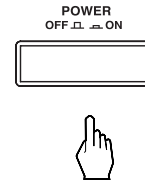

1 Turn the power on.

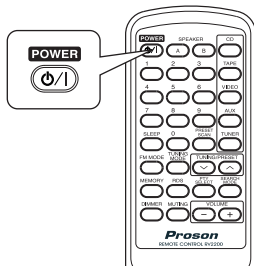

- When the POWER button on the remote control is pressed, this unit is turned on to enter the operating mode.
- In the standby mode, if an INPUT SELECTOR button is pressed, the unit is turned on automatically and the desired input is selected.
- In the operating mode, when the POWER button on the remote control is pressed, then it enters the standby mode.

2 Switch the desired speakers on.

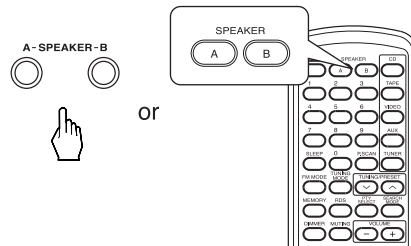

- Then the corresponding speaker indication ("SPK A (or/and) B" is displayed and the sound can be heard from the speakers connected to the selected speaker terminals.
- when ON is selected, the "SPEAKER A (or/and) B" indicator lights.
- When using the headphones for private listening, press the corresponding SPEAKER button to switch off both A and B speakers.

3 Select the desired input source.

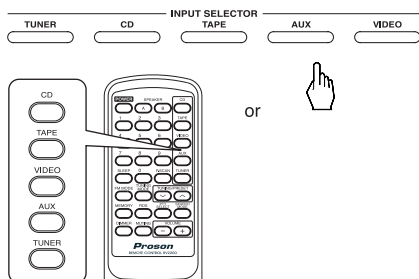

- Each time the FM/AM button on the front panel or the TUNER button on the remote control is pressed, the band is changed to AM or FM.

4 Operate the selected component for playback.

5 Adjust the volume to a comfortable listening level.

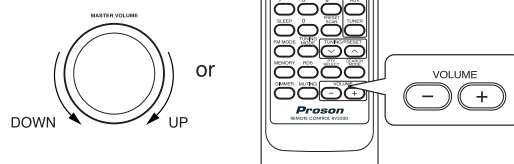

6 To mute the sound.



- “MUTE” lights up and flickers.
- To resume the previous sound level, press this button again.

7 To listen with the headphones.

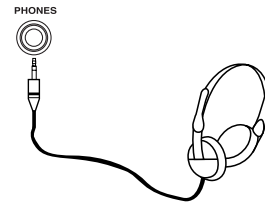

- Be sure to switch off both A and B speakers.

Adjusting the tone(bass and treble)

8 Enter the tone mode.



- Each time this button is pressed, the corresponding tone mode is selected and shown for 3 seconds as follows:

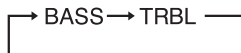

■ Note:

- When the tone direct function is activated, the tone mode cannot be entered and “TON DIR” flickers for 3 seconds.

9 At the desired tone mode, adjust the tone as desired.

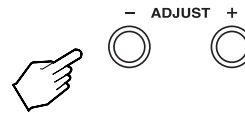

- If the tone display disappears, start from the step 8 again.
- Notes:
 - Extreme settings at high volume may damage your speakers.
 - In general, the bass and treble levels are adjusted to 0.

10 To listen to a program source without the tone effect.



- “TON DIR” is displayed and the sound that bypasses the tone circuitry will be heard.
- To cancel the tone direct function, press this button again to display “TON CTRL”.

Adjusting the sound volume balance

11 Enter the balance mode.

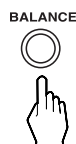

- “BAL” and the balance level is displayed for 3 seconds.

12 Adjust the sound volume balance between the left and right speakers.

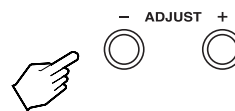

- If the balance display disappears, start from the step 11 again.
- Note:
 - In general, the balance level is set to 0.

LISTENING TO RADIO BROADCASTS

Auto tuning

- 1** Select the tuner and then the desired band.

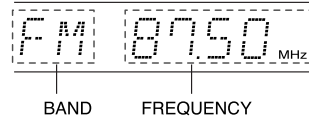
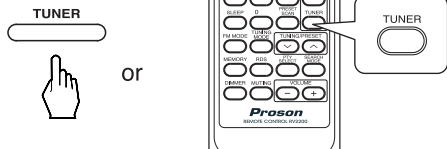

- Each time this button is pressed, the band is changed to FM or AM.

- 2** Select the tuning mode.

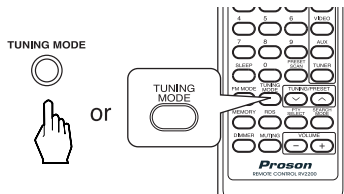

- Each time this button is pressed, the mode changes as follows:

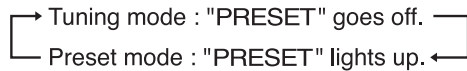

- 3** Press the TUNING/PRESET UP (▲) or DOWN (▼) button for more than 0.5 second.

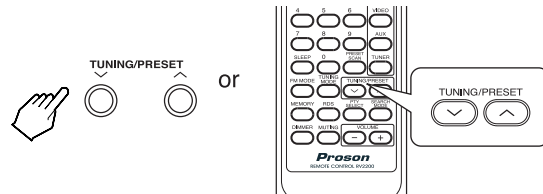

- The tuner will now search until a station of sufficient strength has been found. The display shows the tuned frequency and "TUNED".
- If the station found is not the desired one, simply repeat this operation.
- Weak stations are skipped during auto tuning.

Manual tuning

- Manual tuning is useful when you already know the frequency of the desired station.
- Perform the steps 1 and 2 in "Auto tuning" procedure and press the TUNING/PRESET UP (▲) or DOWN (▼) button repeatedly until the right frequency has been reached.

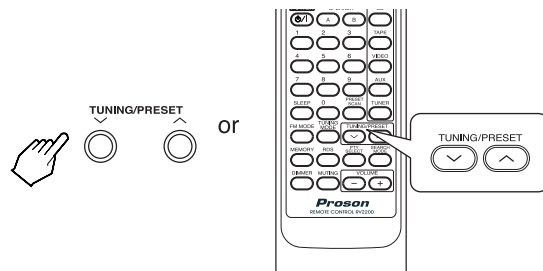

Presetting radio stations

- You can store up to 30 preferred stations in the memory.

- 1** Tune in the desired station with auto or manual tuning.

- 2** Press the MEMORY button.

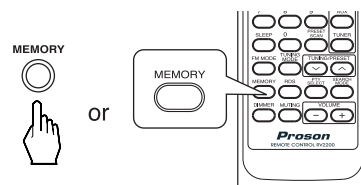

- "MEM" is flickering for 5 seconds.

- 3** Select the desired preset number (1~30) and press the MEMORY button.

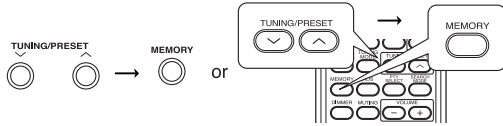

- When using the NUMERIC buttons on the remote control.

Examples) For "3" : 0 within 2 seconds → 3

For "15" : 1 within 2 seconds → 5

For "30" : 3 within 2 seconds → 0

- The station has now been stored in the memory.
- When using the NUMERIC buttons, the station is stored automatically without pressing the MEMORY button.
- A stored frequency is erased from the memory by storing another frequency in its place.
- If "MEM" goes off, start again from the above step 2.

- 4** Repeat the above steps 1 to 3 to memorize other stations.

■MEMORY BACKUP FUNCTION

The following items, set before the receiver is turned off, are memorized.

- INPUT SELECTOR settings
- Preset stations, etc.

■Note

- If the electricity fails or the AC input cord is disconnected for more than several days, they are all cleared. So you should memorize them again.

Tuning to preset stations

- 1** After selecting the tuner as an input source, select the preset mode.

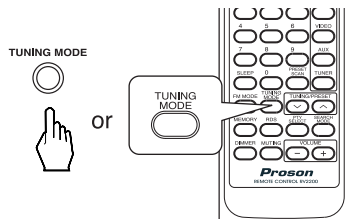

- Then "PRESET" lights up.

- 2** Select the desired preset number.

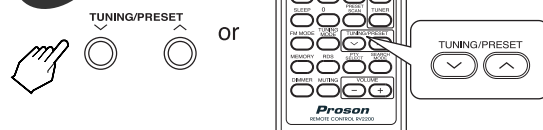

- When using the NUMERIC buttons on the remote control.

Examples) For "3" : 0 within 2 seconds → 3

For "15" : 1 within 2 seconds → 5

For "30" : 3 within 2 seconds → 0

- To select numbers less than 10, press "0" and then the number. As an example, to select number 5, press "0" and "5". (Optionally, you may press just the number "5" and then wait a few seconds.)

Listening to FM stereo broadcasts

- While listening to FM broadcasts,

- Each time this button is pressed, the FM mode changes as follows:

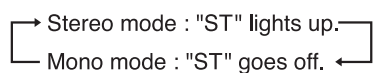

- When FM stereo broadcasts are poor because of weak broadcast signals, select the FM mono mode to reduce the noise, then FM broadcasts are reproduced in monaural sound.

Scanning preset stations in sequence

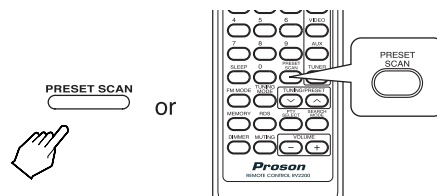

- The receiver will start scanning the stations in the preset sequence.
- At the desired station, press this button again to stop scanning.

LISTENING TO RDS BROADCASTS(FM ONLY)

RDS(Radio Data System) is a method for sending information signals together with the transmitter signals. Your tuner is capable of translating these signals and putting the information on the display. These codes contain the following informations. Program Service name(PS), A list of Program Types(PHY), Traffic Announcement(TA), Clock Time(CT), Radio Text(RT).

RDS search

- Use this function to automatically search and receive the stations offering RDS services.

1 In the FM mode, select the RDS search mode.

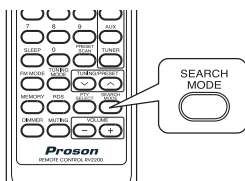

- Each time this button is pressed, the search mode changes as follows;

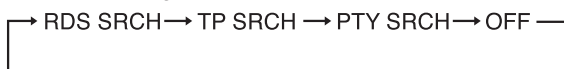

2 While displaying "RDS SRCH"

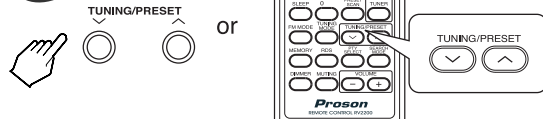

- The tuner automatically searches stations offering RDS services and the station name is displayed.
- If the station found is not the desired one, press the TUNING/PRESET UP(▲/+) or DOWN(▼/-) button again while the RDS indicator is flickering.
- If no other RDS station is found, "NO RDS" is displayed.
- When "RDS SRCH" is not displayed, repeat again from the above step 1.

TP search

- Use this function to automatically search and receive the stations broadcasting the traffic program.

1 In the FM mode, select the TP search mode.

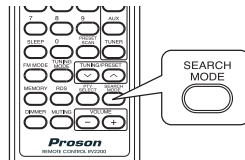

- "TP SRCH" is displayed.

2 While displaying "TP SRCH".

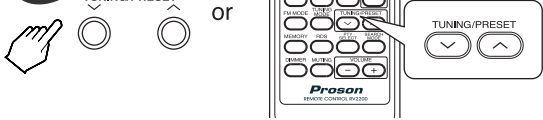

- The tuner automatically searches for stations broadcasting the traffic program.
- "NO TP" is displayed if the signal is too weak or there are no stations broadcasting the traffic program.
- When "TP SRCH" is not displayed, repeat again from the above step 1.

PTY search

- Use this function to automatically search and receive the stations broadcasting the desired program type.

1 In the FM mode, select the PHY search mode.

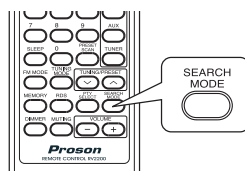

- "PHY SRCH" is displayed.

2 While displaying "PHY SRCH", select the desired program type.

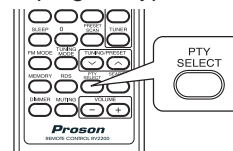

- Each time this button is pressed, one of 32 different types of programs is selected. (NEWS, AFFAIRS, INFO, SPORT, EDUCATE, DRAMA, CULTURE, SCIENCE, VARIED, POP M, ROCK M, EASY M, LIGHT M, CLASSICS, OTHER M, WEATHER, FINANCE, CHILDREN, SOCIAL, RELIGION, PHONE IN, TRAVEL, LEISURE, JAZZ, COUNTRY, NATION M, OLDIES, FOLK M, DOCUMENT, TEST, ALARM, NONE)
- When "PHY SRCH" is not displayed, repeat again from the above step 1.

3

- The tuner automatically searches a station offering PTY services.
- If no station is found, "NO PTY" is displayed.

RDS

In the FM mode.

- Each time this button is pressed, the display mode changes as follows;

```

    graph LR
      A[Frequency] --> B[Program Service name (PS)]
      B --> C[Program Type (PTY)]
      C --> D[Clock Time (CT)]
      D --> E[Radio Text (RT)]
      E --> A
  
```

- If the signals are too weak or no RDS service is available, "NO NAME", "NO PTY", "NO TIME" or "NO TEXT" will be displayed.

RECORDING

- The volume, tone(bass, treble) and balance settings have no effect on the recording signals.
- When you select tuner, CD or AUX as a recording source, recording may be made on TAPE or VIDEO, or both simultaneously.

Recording with TAPE

1 Select the desired input as a recording source except for TAPE.

2 Start recording on the TAPE.

3 Start play on the desired input.

Recording with VIDEO

- 1 Select the desired input as a recording source except for VIDEO.

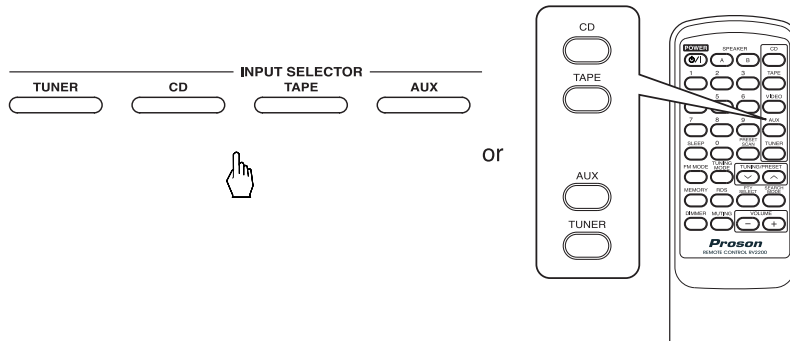

- 2 Start recording on the VIDEO.

- 3 Start play on the desired input.

- The audio signals from the desired input will be recorded onto the VIDEO.

OTHER FUNCTIONS

Operating the sleep timer

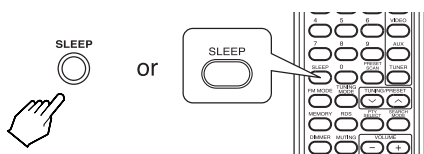

- The sleep timer allows the system to continue to operate for a specified period of time before automatically shutting off.
- To set the receiver to automatically turn off after the specified period of time.
- Each time this button is pressed, the sleep time changes as follows:

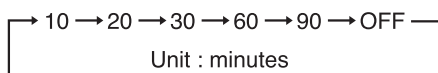

- While operating the sleep timer, SLEEP indicator lights up.
- When the sleep time is selected, the fluorescent display is dimly lit.

Adjusting the brightness of the fluorescent display

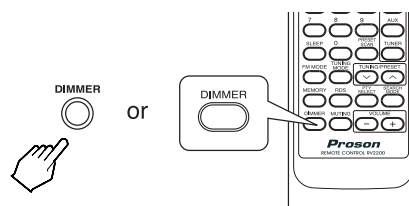

- Each time this button is pressed, the brightness of the fluorescent display changes together as follows:

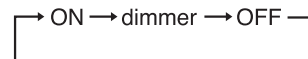

- In the display OFF mode, pressing any button will restore the display ON mode.

Troubleshooting Guide

If a fault occurs, run through the table below before taking your receiver for repair. If the fault persists, attempt to solve it by switching the receiver off and on again. If this fails to resolve the situation, consult with your dealer. Under no circumstances should you repair the receiver yourself as this could invalidate the warranty.

PROBLEM	POSSIBLE CAUSE	REMEDY
No power	<ul style="list-style-type: none"> • The AC input cord is disconnected. • Poor connection at AC wall outlet or the outlet is inactive. 	<ul style="list-style-type: none"> • Connect the cord securely. • Check the outlet using a lamp or another appliance.
No sound	<ul style="list-style-type: none"> • The speaker cords are disconnected. • The volume is adjusted too low. • The MUTING button on the remote control is pressed to ON. • Speakers are not switched on. • Incorrect selection of the input source. • Incorrect connections between the components. 	<ul style="list-style-type: none"> • Check the speaker connections. • Adjust the volume. • Press the MUTING button to cancel the muting effect. • Press the SPEAKER A or B button to ON. • Select the desired input source correctly. • Make connections correctly.
Stations cannot be received	<ul style="list-style-type: none"> • No antenna is connected. • The desired station frequency is not tuned in. • The antenna is in wrong position. 	<ul style="list-style-type: none"> • Connect an antenna. • Tune in the desired station frequency. • Move the antenna and retry tuning.
Preset stations cannot be received	<ul style="list-style-type: none"> • An incorrect station frequency has been memorized. • The memorized stations are cleared. 	<ul style="list-style-type: none"> • Memorize the correct station frequency. • Memorize the stations again.
Poor FM reception	<ul style="list-style-type: none"> • No antenna is connected. • The antenna is not positioned for the best reception. 	<ul style="list-style-type: none"> • Connect an antenna. • Change the position of the antenna.
Continuous hissing noise during FM reception, especially when a stereo broadcast is received.	<ul style="list-style-type: none"> • Weak signals. 	<ul style="list-style-type: none"> • Change the position of the antenna. • Install an outdoor antenna.
Continuous or intermittent hissing noise during AM reception, especially at night.	<ul style="list-style-type: none"> • Noise is caused by motors, fluorescent lamps or lightning, etc. 	<ul style="list-style-type: none"> • Keep the receiver away from noise sources. • Install an outdoor AM antenna.
No recording	<ul style="list-style-type: none"> • Incorrect selection between the components. • Incorrect operation of each component for playback and recording. 	<ul style="list-style-type: none"> • Make connections correctly. • Operate each component correctly.
Remote control unit does not operate.	<ul style="list-style-type: none"> • Batteries are not loaded or exhausted. • The remote sensor is obstructed. 	<ul style="list-style-type: none"> • Replace the batteries. • Remove the obstacle.

Specifications

■ AMPLIFIER SECTION

- Power output, stereo mode, 8 Ω , THD 0.2 %, 20 Hz~20 kHz 2X100 W
- Total harmonic distortion, 8 Ω , 100 W, 20 Hz~20 kHz 0.04 %
- Intermodulation distortion
60 Hz : 7 kHz= 4 : 1 SMPTE, 8 Ω , 100 W 0.1 %
- Input sensitivity, 47 k Ω
Line 200 mV
- Signal to noise ratio, IHF "A" weighted
Line 95 dB
- Frequency response
Line, 10 Hz~100 kHz ± 3 dB
- Output level
TAPE/VCR OUT, 2.2 k Ω 200 mV
- Bass/Treble control, 100 Hz/10 kHz ± 10 dB

■ FM TUNER SECTION

- Tuning frequency range 87.5~108 MHz
- Usable sensitivity, THD 3%, S/N 30 dB 15 dBf
- 50 dB quieting sensitivity, mono/stereo 25.2/45.2 dBf
- Signal to noise ratio, 65 dBf, mono/stereo 68/65 dB
- Total harmonic distortion, 65 dBf, 1 kHz, mono/stereo 0.5/0.8%
- Frequency response, 25 Hz~14 kHz ± 3 dB
- Stereo separation, 1 kHz 35 dB
- Capture ratio 4 dB
- IF rejection ratio 80 dB

■ AM TUNER SECTION

- Tuning frequency range 522~1611 kHz
- Usable sensitivity 800 μ V/m
- Signal to noise ratio 40 dB
- Selectivity 25 dB

■ GENERAL

- Power supply 230V~ 50 Hz
- Power consumption 200W
- Dimensions (W \times H \times D) 440 \times 138 \times 332 mm (17-3/8 \times 5-7/16 \times 13 inches)
- Weight (Net) 9.0 kg (19.85 lbs)

Note: Design and specifications are subject to change without notice for improvements.